

electrodes

23

electrodes for conductivity control.....	684
level electrodes.....	684



electrodes

electrodes for conductivity control

Bores



fig.	GEV No.	mounting ø (mm)	fig.	GEV No.	mounting ø (mm)
1	361068	12	2	361414	22

Meiko



fig.	GEV No.	mounting ø (mm)	fig.	GEV No.	mounting ø (mm)
1	361245	17	2	361274	17

level electrodes

Ambach



fig.	GEV No.	mounting	total length (mm)	probe L (mm)	connection
1	400130	M14x1.25	220	194	F6.3

Animo



fig.	GEV No.	mounting	total length (mm)	probe L (mm)	connection
1	402544	M10	70	40	F6.3

Aristarco



fig.	GEV No.	mounting	total length (mm)	probe L (mm)	connection
1	403236	M10x1.5	73	35	M4

Ascobloc



fig.	GEV No.	mounting	total length (mm)	probe L (mm)	connection
1	400697	PG16	26	20	M5

Bourgeois



fig.	GEV No.	mounting	total length (mm)	probe L (mm)	connection
1	400807	1/2"	112	88	bullet connector



fig.	GEV No.	mounting	total length (mm)	probe L (mm)	connection
2	402987	-	325	-	F6.3



fig.	GEV No.	mounting	total length (mm)	probe L (mm)	connection
3	402986	-	460	-	F6.3

CoffeeQueen



fig.	GEV No.	mounting	total length (mm)	probe L (mm)	connection
1	402837	thread	55	38	-

Comenda



fig.	GEV No.	mounting	total length (mm)	probe L (mm)	connection
1	403254	M10x1.5	55	30x40	M4

Convotherm



fig.	GEV No.	mounting	total length (mm)	probe L (mm)	connection
1	400076	1/2"	190	125/155	bullet connector



fig.	GEV No.	mounting	total length (mm)	probe L (mm)	connection
2	400075	1/2"	270	185/235	bullet connector



fig.	GEV No.	mounting	total length (mm)	probe L (mm)	connection
3	401869	flange with thread	185	160/30	bullet connector

Cookmax



fig.	GEV No.	mounting	total length (mm)	probe L (mm)	connection
1	402104	flange with thread	175	155/115/90/60/45/30	F2.8

Electrolux



fig.	GEV No.	mounting	total length (mm)	probe L (mm)	connection
1	400405	1/4"	345	320	F6.3



fig.	GEV No.	mounting	total length (mm)	probe L (mm)	connection
2	400124	push-in	128	103	F6.3



fig.	GEV No.	mounting	total length (mm)	probe L (mm)	connection
3	401548	push-in	175	151	F6.3

Elframo



fig.	GEV No.	mounting	total length (mm)	probe L (mm)	connection
1	403263		75		
1	403264		125		

Emmepi



fig.	GEV No.	mounting	total length (mm)	probe L (mm)	connection
1	400021	PG9	110	70/47/24	grip connection
1	400022	PG9	135	89/59/28	grip connection

Fagor



fig.	GEV No.	mounting	total length (mm)	probe L (mm)	connection
1	400163	PG9	100	72/43/22	grip connection



fig.	GEV No.	mounting	total length (mm)	probe L (mm)	connection
2	400021	PG9	110	70/47/24	grip connection
2	400022	PG9	135	89/59/28	grip connection



fig.	GEV No.	mounting	total length (mm)	probe L (mm)	connection
3	400884	push-in	105	95	M4
3	400885	push-in	120	110	M4
3	400886	push-in	130	120	M4

Falcon



fig.	GEV No.	mounting	total length (mm)	probe L (mm)	connection
1	403183	3/8"	162	11	M3



fig.	GEV No.	mounting	total length (mm)	probe L (mm)	connection
2	403143	2 hole flange	100	-	M6x1



fig.	GEV No.	mounting	total length (mm)	probe L (mm)	connection
3	403144	2 hole flange	215	116	M6x1

Gicar



fig.	GEV No.	mounting	total length (mm)	probe L (mm)	connection
1	401161	1/4"	210	184	F6.3
1	400130	M14x1.25	220	194	F6.3



2



fig.	GEV No.	mounting	total length (mm)	probe L (mm)	connection
2	400405	1/4"	345	320	F6.3

3



fig.	GEV No.	mounting	total length (mm)	probe L (mm)	connection
3	401548	push-in	175	151	F6.3

GIGA

1



fig.	GEV No.	mounting	total length (mm)	probe L (mm)	connection
1	400130	M14x1.25	220	194	F6.3

Granuldisk

1



fig.	GEV No.	mounting	total length (mm)	probe L (mm)	connection
1	403322	3/8"	75	46	M4

Groen USA

1



fig.	GEV No.	mounting	total length (mm)	probe L (mm)	connection
1	403183	3/8"	162	11	M3

Hobart

1



fig.	GEV No.	mounting	total length (mm)	probe L (mm)	connection
1	402986	-	460	-	F6.3

Hoonved

1

2

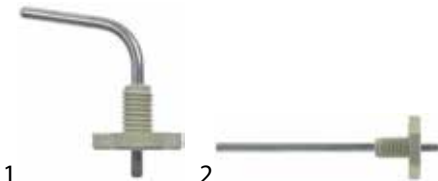

fig.	GEV No.	mounting	total length (mm)	probe L (mm)	connection
1	361385	1/8"	55	40x40	M4
2	361386	1/8"	95	82	M4

3



fig.	GEV No.	mounting	total length (mm)	probe L (mm)	connection
3	512072	1/2"	78.5	63	M5x0.8

Icematic

1



fig.	GEV No.	mounting	total length (mm)	probe L (mm)	connection
1	403562	push-in	120	95	F6.3

Inomak

1



fig.	GEV No.	mounting	total length (mm)	probe L (mm)	connection
1	403296	push-in	167	115	F6.3

Juno

1



fig.	GEV No.	mounting	total length (mm)	probe L (mm)	connection
1	400405	1/4"	345	320	F6.3

2



fig.	GEV No.	mounting	total length (mm)	probe L (mm)	connection
2	400124	push-in	128	103	F6.3

3



fig.	GEV No.	mounting	total length (mm)	probe L (mm)	connection
3	401548	push-in	175	151	F6.3

Krefftt

1



fig.	GEV No.	mounting	total length (mm)	probe L (mm)	connection
1	400021	PG9	110	70/47/24	grip connection
1	400022	PG9	135	89/59/28	grip connection

Küppersbusch

1





fig.	GEV No.	mounting	total length (mm)	probe L (mm)	connection
1	400072	push-in	100	90	F6.3
1	400071	push-in	170	155	F6.3

Lainox



1

fig.	GEV No.	mounting	total length (mm)	probe L (mm)	connection
1	400130	M14x1.25	220	194	F6.3

Lincat



1

fig.	GEV No.	mounting	total length (mm)	probe L (mm)	connection
1	401912	1/8"	230	225	bullet connector

Mach



1

fig.	GEV No.	mounting	total length (mm)	probe L (mm)	connection
1	504138	M10	56	30	bullet connector

Marco



1

fig.	GEV No.	mounting	total length (mm)	probe L (mm)	connection
1	402777	1/4"	140	127	M4

Mareno



1

fig.	GEV No.	mounting	total length (mm)	probe L (mm)	connection
1	401161	1/4"	210	184	F6.3

MBM-Italia



1

fig.	GEV No.	mounting	total length (mm)	probe L (mm)	connection
1	401161	1/4"	210	184	F6.3

Meiko



1

fig.	GEV No.	mounting	total length (mm)	probe L (mm)	connection
1	403314	1/2"	150	125	bullet connector

Melitta



1

fig.	GEV No.	mounting	total length (mm)	probe L (mm)	connection
1	402104	flange with thread	175	155/115/90/60/45/30	F2.8

MKN



1

fig.	GEV No.	mounting	total length (mm)	probe L (mm)	connection
1	401409	1/4"	132	102	F6.3



2

fig.	GEV No.	mounting	total length (mm)	probe L (mm)	connection
2	401458	M10x1	132	112	F6.3

Morice



1

fig.	GEV No.	mounting	total length (mm)	probe L (mm)	connection
1	403136	M4	150	145	F6.3
1	403135	M4	200	12	F6.3

Palux



1

fig.	GEV No.	mounting	total length (mm)	probe L (mm)	connection
1	400697	PG16	26	20	M5



Pavoni



1

fig.	GEV No.	mounting	total length (mm)	probe L (mm)	connection
1	402549	1/4"	125	100	F6.3

Rational



1

fig.	GEV No.	mounting	total length (mm)	probe L (mm)	connection
1	403138	PG9	100	85	coded plug



2

fig.	GEV No.	mounting	total length (mm)	probe L (mm)	connection
2	400163	PG9	100	72/43/22	grip connection



3

fig.	GEV No.	mounting	total length (mm)	probe L (mm)	connection
3	400021	PG9	110	70/47/24	grip connection
3	400022	PG9	135	89/59/28	grip connection



4

fig.	GEV No.	mounting	total length (mm)	probe L (mm)	connection
4	403298	M15x1.5	110	85	coded plug



5

fig.	GEV No.	mounting	total length (mm)	probe L (mm)	connection
5	403297	M15x1.5	190	165	coded plug

Retigo



1

fig.	GEV No.	mounting	total length (mm)	probe L (mm)	connection
1	403295	M16x1	205	148	3-wire



2

fig.	GEV No.	mounting	total length (mm)	probe L (mm)	connection
2	403353	push-in	225	185	bullet connector

Rieber



1

fig.	GEV No.	mounting	total length (mm)	probe L (mm)	connection
1	401590	PG21	50	10	grip connection

Rosinox



1

fig.	GEV No.	mounting	total length (mm)	probe L (mm)	connection
1	403131	1/4"	330	270	M4



2

fig.	GEV No.	mounting	total length (mm)	probe L (mm)	connection
2	400171	1/4"	350	325	F6.3



3

fig.	GEV No.	mounting	total length (mm)	probe L (mm)	connection
3	512072	1/2"	78.5	63	M5x0.8

4

fig.	GEV No.	mounting	total length (mm)	probe L (mm)	connection
4	400021	PG9	110	70/47/24	grip connection
4	400022	PG9	135	89/59/28	grip connection

Silko



1

fig.	GEV No.	mounting	total length (mm)	probe L (mm)	connection
1	400171	1/4"	350	325	F6.3



Therma



1

fig.	GEV No.	mounting	total length (mm)	probe L (mm)	connection
1	400124	push-in	128	103	F6.3

Zanussi



1

fig.	GEV No.	mounting	total length (mm)	probe L (mm)	connection
1	400124	push-in	128	103	F6.3

Wiesheu-Wiwa



1

fig.	GEV No.	mounting	total length (mm)	probe L (mm)	connection
1	400065	M15x1.5	135	77/67/57	grip connection

Zanussi



2

fig.	GEV No.	mounting	total length (mm)	probe L (mm)	connection
2	401548	push-in	175	151	F6.3



528544
528545
528546
528547
528576
528574
528573
528572
528575

528552
528556

528579
528578

NO-STO
528582
528562

528565

ORDER NOW

FILTER

Applications
coffee machines

Categories
electric components
pump components
mechanical components, equipment
accessories
tools, fastening materials,
consumables
water technology

Appliances
ATA
Adamo
Adler
Amalis
Ambach
Angelus Pro
Anano
Arstarc
Ascoloc
Avukuh
Astoria
Bake-Off
Bran
Dartscher
Berlto
Bizzera

EXPLODED VIEWS
Available round the clock in the GEV Webshop and App

